



## SDM72D-M-2

### Three Phase Four Wire Energy Meter



- Multi-parameter measurement
- Resettable partial energy
- Bi-directional measurement IMP & EXP
- Pulse Output
- RS485 Modbus
- Din rail mounting 35mm
- Direct connection, up to 100A
- Better than Class 1/ B accuracy

**User Manual V1.1.1 2023**

## Introduction

The SDM72D-M-2 is digital 3 phase 4 wires energy meter with white back-lighted LCD screen for perfect reading. The unit measures and displays voltage, current, frequency, power factor, active power, reactive power, active energy and reactive energy, etc. A resettable partial energy is provided, so the user can easily check the active energy imported and active energy exported during a certain period. SDM72D-M-2 supports max.100A direct connection, saving the cost and avoiding the trouble to connect external CTs, giving the unit a cost-effective and easy operation. Built-in interfaces provide pulse and RS485 Modbus RTU outputs. Configuration is password protected.

# PART 1 Specification

## General Specifications

Voltage AC (Un)	3x230(400)V
Voltage Range	80~120% Un
Base Current (Ib)	10A AC
Max. Current (Imax)	100A AC
Mini Current (Imin)	5% of Ib AC
Starting current	0.4% of Ib
Power consumption	≤ 2W/10VA for the voltage measuring circuit ≤ 4VA for the current measuring circuit
Frequency	50/60Hz (non-MID); 50Hz(MID)
AC voltage withstand	4KV for 1 minute
Impulse voltage withstand	6KV-1.2uS waveform
Overcurrent withstand	30 Imax for 0.01s
Power supply	self-power supply
Display	LCD with backlit
Max. Reading	999999.9kWh
Active energy	Class 1 IEC62053-21 (non-MID) Class B EN50470-1/3 (MID)
Reactive energy	Class 2 IEC62053-23

## Unit Characteristics

Characteristics:	Accuracy:	Resolution:
● Voltage	0.5%	≤ 0.1V
● Current	0.5%	≤ 0.1A
● Frequency	0.2%	≤ 0.2%
● Power factor	1%	≤ 0.1
● Active power	1%	≤ 0.1kW
● Reactive Power	1%	≤ 0.1 kVAr
● Active energy imported and exported	1%	≤ 0.1kWh
● Reactive energy	2%	≤ 0.1 kVArh

**RS485 Serial – Modbus RTU**

This unit uses an RS485 serial port with Modbus RTU protocol to provide a means of remotely monitoring and controlling the Unit.

Set-up screens are provided for setting up the RS485 port.

**Pulse output**

The unit provides pulse output for active kWh. The Pulse output is passive type.

Pulse constant: 1000imp/kWh

Pulse width: 35mS

Direction for Pulse: Import

**RS485 Output for Modbus RTU**

For Modbus RTU, the following RS485 communication parameters can be configured from the Set-up menu:

**Baud rate** 1200,2400, 4800, 9600, 19200 bps

**Parity** none (default)/odd/even

**Stop bits** 1 or 2

**RS485 network address** *nnn* – 3-digit number, 001 to 247

**Modbus™ Word order** Hi/Lo byte order is set automatically to normal or reverse. It cannot be configured from the set-up menu.

**Environment**

Operating temperature	3K6 (-25°C to +55°C) (default)
	3K7 (-40°C to +70°C) (optional)
Storage and transportation temperature	-40°C to +70°C
Reference temperature	23°C ± 2°C
Relative humidity	0 to 95%, non-condensing
Altitude	up to 2000m
Warm up time	3s
Installation category	CAT III
Mechanical Environment	M1
Electromagnetic environment	E2
Degree of pollution	2





**Mechanics**

Din rail dimensions	72x100x66 (WxHxD) DIN 43880
Mounting	DIN rail 35mm
Protection against penetration of dust and water	IP51 (indoor)
Material	self-extinguishing UL94V-0

## PART 2 Operation



### Initialization Display

When it is powered on, the meter will initialize and do self-checking.

	Full Screen
	Software Version
	Pulse constant
	Total active energy(kWh) Total=Import+ Export 5+2 -> 6+1 Max. reading: 999999.9 kWh







### Buttons function

There are two buttons on the front panel.

	>Scroll the display for data-check. >Change option at Set-up mode >Exit the Set-up mode
	>Set-up mode entry >Confirmation





Scroll display

After initialization and self-checking program, the meter displays the measured values. The default page is total kWh. If the user wants to check other information, please press the scroll button  on the front panel.

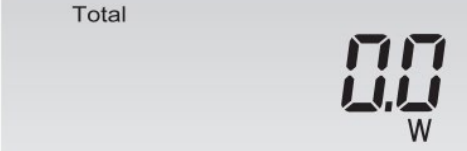
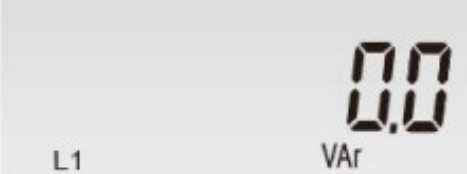
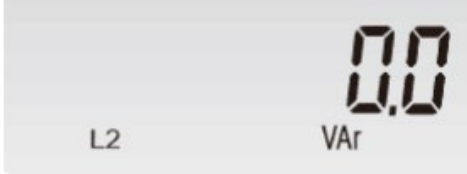
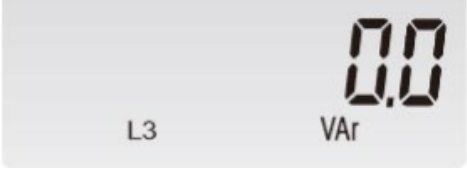
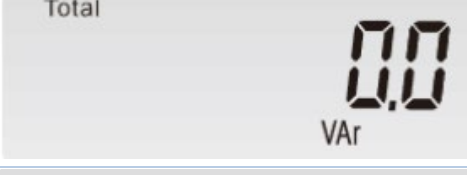
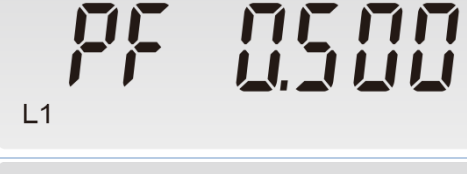
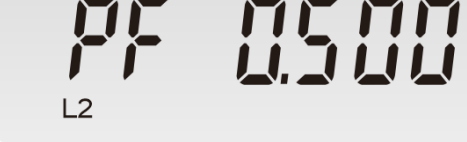
	Total active energy Total=Import+ Export
	Resettable partial kWh Total=Import+ Export
	Import energy
	Export energy
	Total reactive energy
	Resettable reactive energy

 <p>L1 230.0 V</p>	Voltage L1-N
 <p>L2 230.1 V</p>	Voltage L2-N
 <p>L3 230.2 V</p>	Voltage L3-N
 <p>L1 60.023 A</p>	L1 current
 <p>L2 60.023 A</p>	L2 current
 <p>L3 60.023 A</p>	L3 current
 <p>L1 450.4 W</p>	L1 active power
 <p>L2 437.6 W</p>	L2 active power



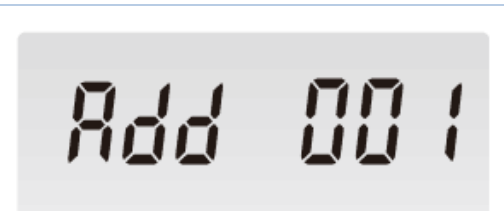
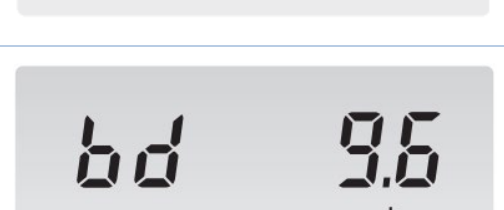
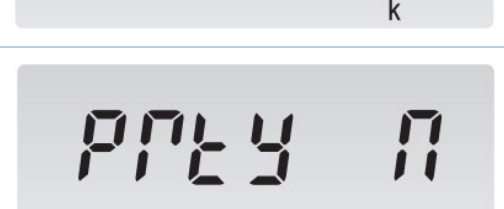
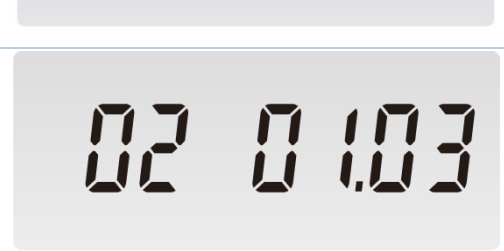











 <p>L3 44.19 W</p>	L3 active power
 <p>Total 0.0 W</p>	Total active power
 <p>L1 0.0 VAr</p>	L1 reactive power
 <p>L2 0.0 VAr</p>	L2 reactive power
 <p>L3 0.0 VAr</p>	L3 reactive power
 <p>Total 0.0 VAr</p>	Total reactive power
 <p>L1 PF 0.500</p>	L1 Power factor
 <p>L2 PF 0.500</p>	L2 power factor

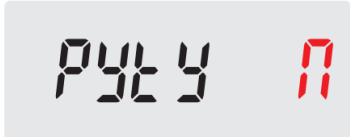

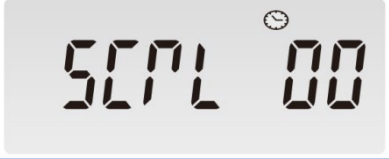
	<p>L3 power factor</p>
	<p>Total Power factor</p>
	<p>Frequency</p>
	<p>Pulse output type: Default: kWh Pulse constant: 1000imp</p>
	<p>Modbus Address</p>
	<p>Baud Rate</p>
	<p>Parity</p>
	<p>Software version</p>

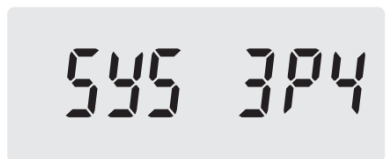

Set-up Mode

To get into Set-up Mode, the user need to press the “Enter” button  for 3 seconds.

Setting interface	Setting status	Option:
		Password Default: 1000
		Modbus address Rane:001~247 default:001
		Buad rate Option: 1200,2400,4800,9600, 19200 bps default: 9600 bps
		Parity: Option:NONE,EVEN,ODD default:NONE
		Stop bit Option:1,2 default: 1
		Automatic Scroll display set Range:0~60,unit:second default:05, 0 means do not scroll
		Backlit time setting Option: on,5,10,30,60,120,off unit: minute default: 60 minute
		System: Option: 3P4W,1P2W default: 3P4W

		Password: default:1000
		Resettable partial energy

Keep pressing button  to exit the set-up mold.

**Wiring diagram**

**Terminals**

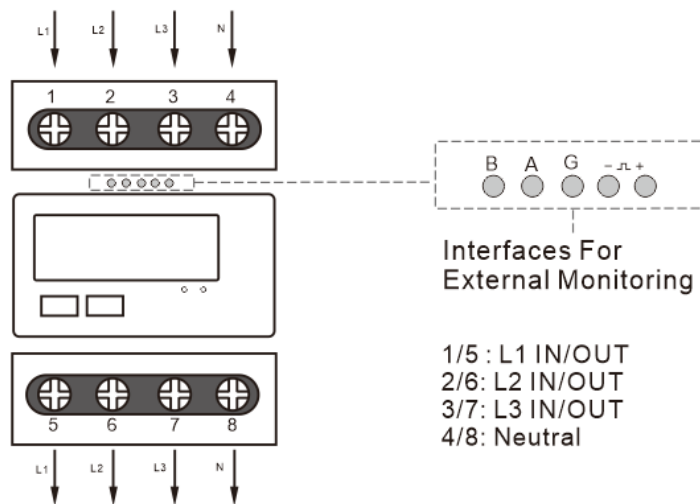

### 3 phase 4 wire

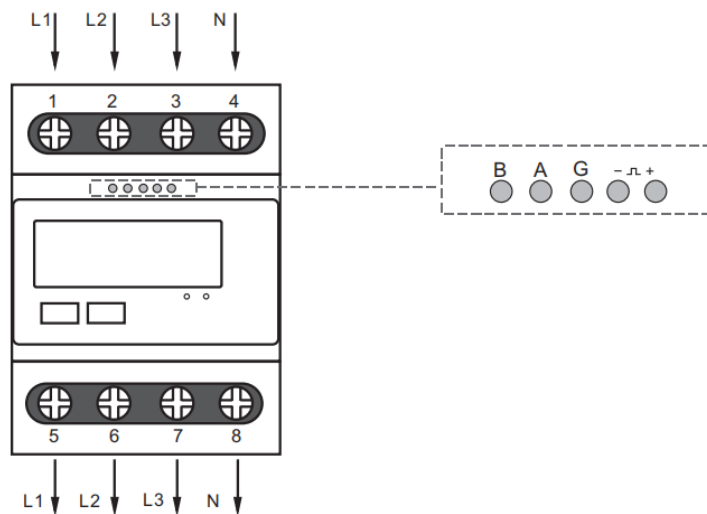

### 1 phase 2 wire

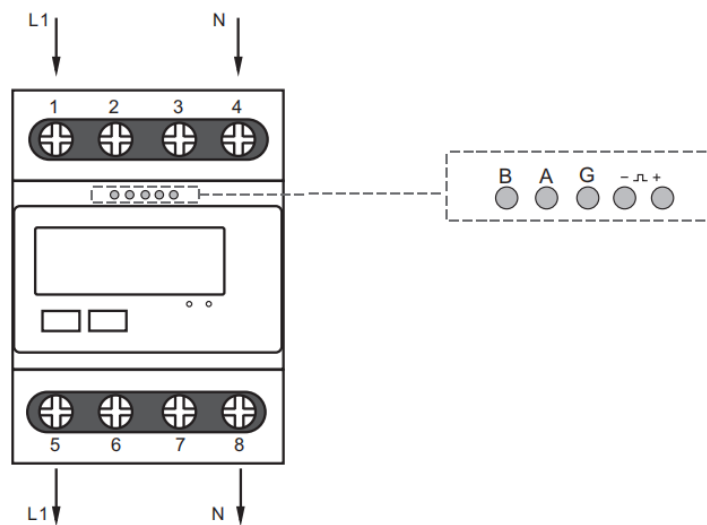

NOTE:

Maximum Wire Size for Mainload: 25mm<sup>2</sup>

### Dimensions

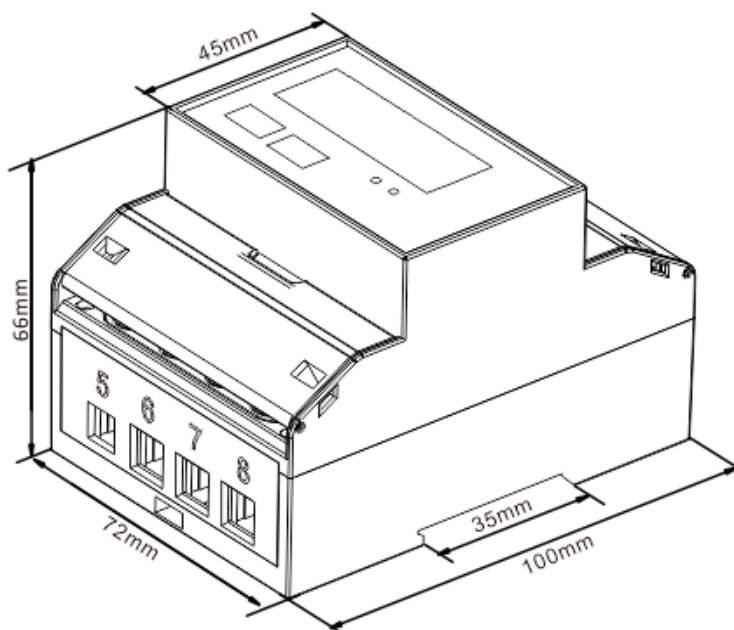

### Installation

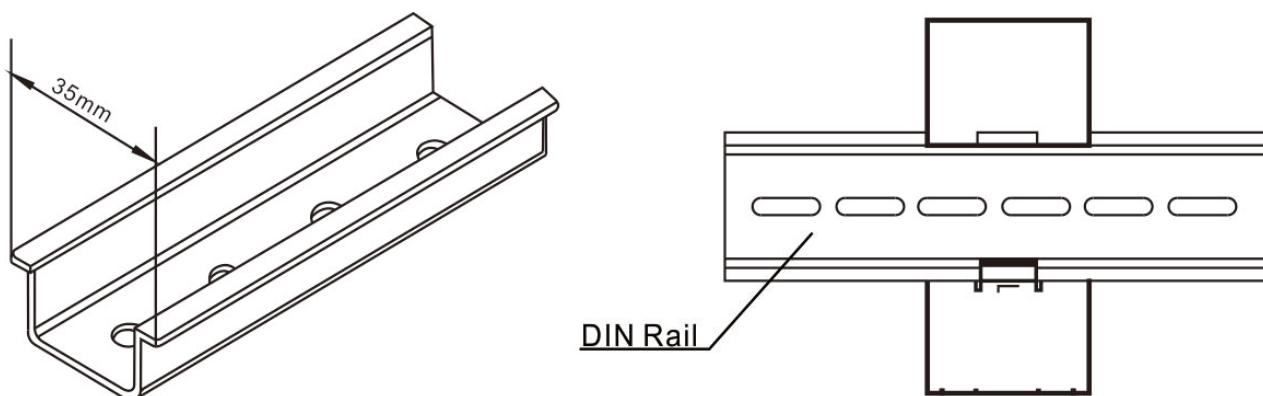



30049	Sum of line currents.	4	Float	A	00	30
30053	Total system power.	4	Float	W	00	34
30057	Total system volt amps.	4	Float	VA	00	38
30061	Total system VAr.	4	Float	VAr	00	3C
30063	Total system power factor (1).	4	Float	None	00	3E
30071	Frequency of supply voltages.	4	Float	Hz	00	46
30073	Import active energy	4	Float	kWh	00	48
30075	Export active energy	4	Float	kWh	00	4A
30201	Line 1 to Line 2 volts.	4	Float	V	00	C8
30203	Line 2 to Line 3 volts.	4	Float	V	00	CA
30205	Line 3 to Line 1 volts.	4	Float	V	00	CC
30207	Average line to line volts.	4	Float	V	00	CE
30225	Neutral current.	4	Float	A	00	E0
30343	Total active Energy (2)	4	Float	kWh	01	56
30345	Total reactive energy	4	Float	kVarh	01	58
30385	resettable total active energy	4	Float	kWh	01	80
30387	Resettable total reactive energy	4	Float	kVarh	01	82
30389	resettable import active energy	4	Float	kWh	01	84
30391	resettable export active energy	4	Float	kWh	01	86
30397	Net kWh (Import - Export)	4	Float	kWh	01	8C
31281	Total import active power	4	Float	W	05	00
31283	Total export active power	4	Float	W	05	02

Instruction:

- 1: The power factor has its sign adjusted to indicate the direction of the current. Positive refers to forward current, negative refers to reverse current.
- 2: Total active energy equals to import + export.

**Holding Registers**

Holding register are used to store and display instrument configuration settings. All holding registers not listed in the table below should be considered as reserved for manufacturer use and no attempt should be made to modify their values.

The holding register parameters may be viewed or changed using the Modbus Protocol. Each parameter is held in two consecutive 4X registers. Modbus Protocol Function Code **03** is used to read the parameter and Function code **10** is used to write. Write only to one parameter per message.

Address Register	Parameter	Modbus Protocol Start Address Hex	Valid range	Mode
------------------	-----------	-----------------------------------	-------------	------

		High Byte	High Byte		
40011	System Type	00	0A	Write system type: 1 = 1P2W; 3 = 3P4W,(default); <b>Length : 4 byte</b> <b>Data Format : Float</b> (KPPA is asked)	r/w
40013	Pulse width	00	0C	Range: 60, 100, 200, unit: ms, default 100. Note: If pulse output =1000imp/kWh, then pulse width is fixed at 35ms, and cannot be adjusted. <b>Length : 4 byte</b> <b>Data Format : Float</b>	r/w
40015	Key Parameter Programming Authorization (KPPA)	00	0E	Read: to get the status of the KPPA 0 = not authorized; 1 = authorized Write the correct password to get KPPA, enable to program key parameters. <b>Length : 4 byte</b> <b>Data Format : Float</b>	r/w
40019	Parity and stop bit	00	12	Write the network port parity/stop bits for MODBUS Protocol, where: 0 = One stop bit and no parity, default. 1 = One stop bit and even parity. 2 = One stop bit and odd parity.3 = Two stop bits and no parity. <b>Length : 4 byte</b> <b>Data Format : Float</b>	r/w
40021	Modbus address	00	14	Write the network port node Address: 1 to 247 default 1. <b>Length : 4 byte</b> <b>Data Format : Float</b>	r/w
40023	Pulse constant	00	16	Option: 0~3, default 0 0 :1000 imp/kWh 1 : 100 imp/kWh 2: 10 imp/kWh 3: 1 imp/kWh Note: If pulse output	r/w

				=1000imp/kWh, then pulse width is fixed at 35ms, and cannot be adjusted. <b>Length : 4 byte</b> <b>Data Format : Float</b>	
40025	Password	00	18	Read: to get the password of the meter Write: to program the new password of the meter Default 1000 <b>Length : 4 byte</b> <b>Data Format : Float</b>	r/w
40029	Network Baud Rate	00	1C	Write the network port baud rate for MODBUS Protocol, where: 0 = 2400 baud. 1 = 4800 baud. 2 = 9600 baud(default). 3 = 19200 baud 5 = 1200 band <b>Length : 4 byte</b> <b>Data Format : Float</b>	r/w
40059	Automatic Scroll Display Time	00	3A	Default 0, second Range 0~60 <b>Length : 4 byte</b> <b>Data Format : Float</b>	r/w
40061	Backlit time	00	3C	Default 60, min Range 0~121, 0 means backlit always on, 121 means backlit always off <b>Length : 4byte</b> <b>Data Format : Float</b>	r/w
40087	Pulse 1 Energy Type	00	56	Pulse 1 Energy Type: 1: import active energy 2: total active energy (default) 4: export active energy <b>Length : 4 byte</b> <b>Data Format : Float</b>	r/w
461457	Reset historical data	F0	10	00 03 = reset energy info <b>Length : 2 byte</b> <b>Data Format: Hex</b>	wo



464513	Serial number	FC	00	Serial number <b>Length : 4 byte</b> <b>Data Format : unsigned int32</b> <b>Note: Only read</b>	ro
464515	Meter code	FC	02	Meter code SDM72D-M-2= 00 89 <b>Length : 2 byte</b> <b>Data Format : Hex</b> <b>Note: Only read</b>	ro
464645	Software version	FC	84	The software showed on display XX.YY <b>Format: XX= first byte; YY= second byte</b> <b>Length: 2 byte</b> <b>Data Format: Hex</b> <b>Note: Read only</b>	ro

If you have any question, please feel free to contact our sales team.

**Zhejiang Eastron Electronic Co., Ltd.**

No.1369, Chengnan Rd. Jiaxing, Zhejiang, 314001, China

Tel: +86-573-83698881 Fax: +86-573-83698883

Email: sales@eastrongroup.com

[www.eastrongroup.com](http://www.eastrongroup.com)